

LARGE FORMAT LENSES





Computer-controlled manufacturing processes guarantee a constant and high level of quality



Only the best, optically homogeneous glasses are used for Schneider lenses.



In ultra-modern vacuum coating facilities, a reflex-reducing layer is applied



SCHNEIDER-KREUZNACH: The Reliable Partner of Professionals

High-quality optical photographic and reproduction systems are among the most complex products which an industry can manufacture. For that reason only a few manufacturers can maintain a position worldwide in this professional market. We are proud to be among them: SCHNEIDER-KREUZNACH has been synonymous with high-performance lenses of the highest class for over 90 years.

The confidence that professionals the world around have placed in SCHNEIDER-KREUZNACH lenses is not based solely on the long tradition and almost legendary reputation of world-renowned lenses like the APO-SYMMAR, XENAR, SUPER-ANGULON or COMAPONON. Rather, SCHNEIDER-KREUZNACH combines extensive experience in lens construction with the most modern computational, design, manufacturing, and testing methods to achieve extraordinary competence, which is the basis for the highest possible level of quality.

This begins with the creation of new products in close cooperation with experienced users, in order to find solutions which meet practical needs when judged by really relevant criteria. Then, in the design stage, the engineers have access to over 130 kinds of glass, and from these data they optimize lens systems with modern high-powered computers by means of elaborate calculations supported by computer-assisted design. Countless prototypes are produced in order to

demonstrate their potential in exacting testing and measurement procedures as well as in hard practical tests. Only when they meet all the required parameters of quality without limitation does mass production begin. In order to maintain the highest level of quality even there, very strict inspections are integrated into all production steps, such as grinding, polishing, centering, or coating. That applies equally for the manufacturing of the mounts and of other mechanical parts, up to and including the assembly of all the components into complete systems. And at the end of the process, before shipping, every single lens (not just random samples!) is subjected to a thorough test for quality and performance. The sole purpose of all these measures is to be able to offer lenses of the highest quality for photography, reproduction, enlargement, and projection to the discriminating professional user.

Although production cycles in the area of electronics are becoming shorter and shorter, the users of lenses from SCHNEIDER-KREUZNACH in making their decision always expect long-term use, a condition which presupposes a level of quality at the cutting edge of technological achievement. SCHNEIDER-KREUZNACH has also adhered to this principle in connection with the expansion of its product line in the direction of digital image systems, so as to remain, not only today, but also in the future, a significant and reliable partner of the professional.



Strict inspections on all stages of production up to the final checkout guarantee that the lens will have the image quality defined by computer

Our range of products



Photo-optics

Photographic and enlarging lenses of the very highest order for all areas of professional photography, both analog and digital, from 35 mm to large format.



B+W filters

The leading brand for demanding professionals and amateur photographers for creative photography in conjunction with best image quality: correction and contrast filters for color and black & white photos, K&Semann polarization filters, close-up lenses, special-effect and trick lenses, filters with SLIM-mounts for pictures free from vignetting with wide-angle zoom and fixed focal-length lenses.



CCTV/OEM

Infrared-corrected CCTV lenses, high-resolution C-mount lenses, and macro systems for image processing and non-contact measurement technology, as well as customized development and manufacture of optical and mechanical components.



Cinema projection

High-performance cinema projection lenses for 16 mm, 35 mm, and 70 mm film, anamorphic close-up lenses, wide-angle projection lenses for 70 mm film with 8 or 10 pitch, test films for 35 mm projection.



Digital projection

A new cine-digital series for digital high-performance projectors, with lenses tightly staggered in fixed focal lengths, and anamorphic projection lenses which can be relied on for contrast and sharpness of detail. The areas of application of these new lenses extends from digital cinema through fixed installations in front and rear projection to applications for rental and staging.



Ophthalmic optics

Eyeglass lenses of glass and plastic; single-focus, multifocal, and gradient-focus lenses of high-refractive materials with special glass configuration for better appearance and wearing comfort.



Servo-hydraulic system

Electro-hydraulic and electro-pneumatic servo valves with high-grade electronic control units for precise position, speed, power, and pressure adjustments in machine construction.

LARGE FORMAT AND ...

Professional large-format photography distinguished by creativity and technical perfection

While small picture sizes are dominant in amateur and professional sport and reporting photography (and while the digital cameras which have become more and more widely used there are continuing the



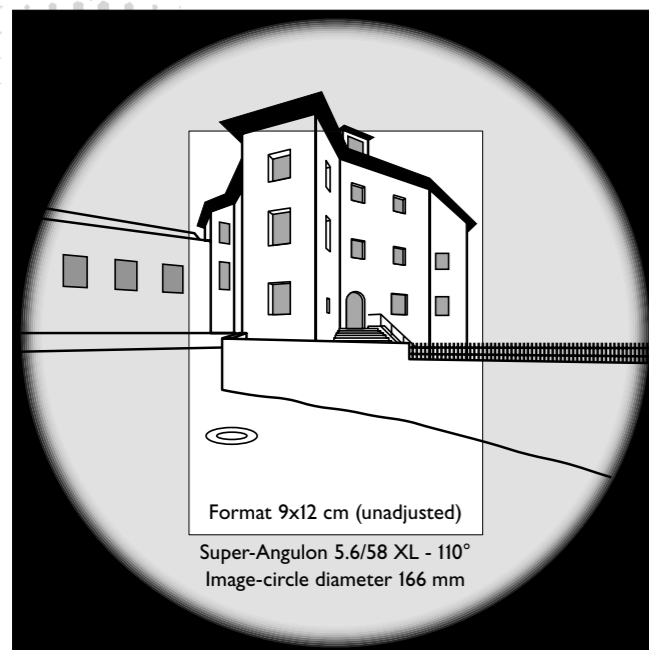
Baseboard cameras can be used hand-held, and are considered the classical tool of the landscape, industrial, and architectural photographer



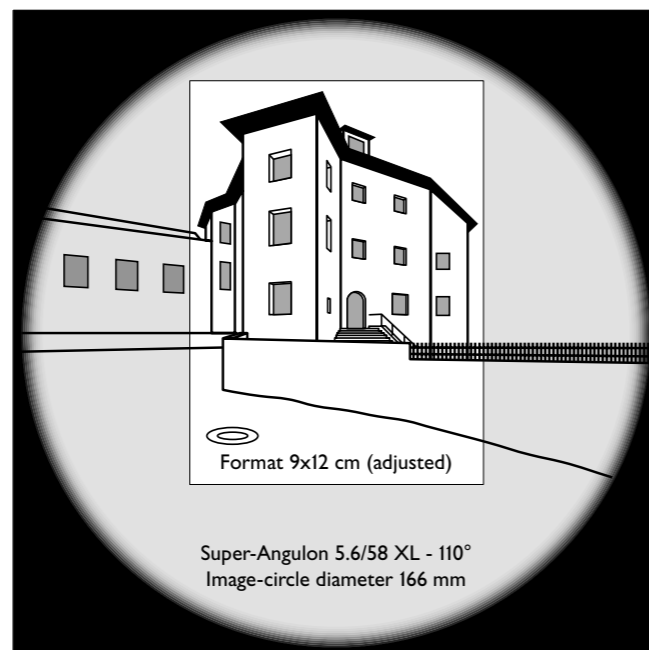
Shift cameras which can be used without a tripod, like other adjustable cameras, require lenses with an extra-large image circle

trend to miniaturization), adjustable medium and large format cameras have been able to maintain their position in the area of professional photography. The reason is that in the most important areas of product and advertising photography, technical documentation, architecture and industrial photography, as well as nature and landscape photography for illustrated books, calendars, and picture postcards, what is demanded, on the one hand, is the best resolution and brilliance, true-to-nature reproduction of material structures, as well as freedom from distortion, and on the other hand, perfectly controlled representation of perspective. Of course, creativity can also be found in smaller picture formats, but in the applications named the technical quality cannot lag behind the artistic and formal.

For that reason, the first characteristic feature of the camera used in professional photography is a



As a rule, buildings are photographed from eye level, and not from a point half-way up the height of the building. When the camera is pointed upward at an angle, "converging vertical lines" result; hence, the focusing screen must be vertical.



If, despite the large field of view of a wide-angle lens, the upper part of the building is cut off when the camera is in a vertical position, the lens must be moved upward while remaining in a parallel position. For this reason, a large image circle is needed.

PERSPECTIVE CONTROL

large format (in this connection, "large" today begins with 6x7 cm roll film and ends with film 18x24 cm or 8x10 inches) as a guarantee of the highest richness of detail and non-grainy surface appearance, even at the highest degree of enlargement. The second characteristic, which is even more important for its practical implications, is the capability of versatile mechanical adjustment for corrections of perspective with direct or indirect parallel displacement for the rectification of converging vertical parallel lines or for intentional distortions and for Scheimpflug depth of field control by lens tilt and swing.

Tilt, swing and shifts are realized with the camera, but sharpness and brilliance depend on the lens

Not only the amateur, but even the professional himself regards the camera as the primary "tool" of the photographer, which shows how much the role of the lens is often underestimated in the creation and success of the picture.

The photographer and his client expect from a professional studio, architecture, or landscape photo perfect sharpness, brilliance (high contrast in replication of structure), natural color, freedom from color fringes, even image field illumination, and freedom from distortion.



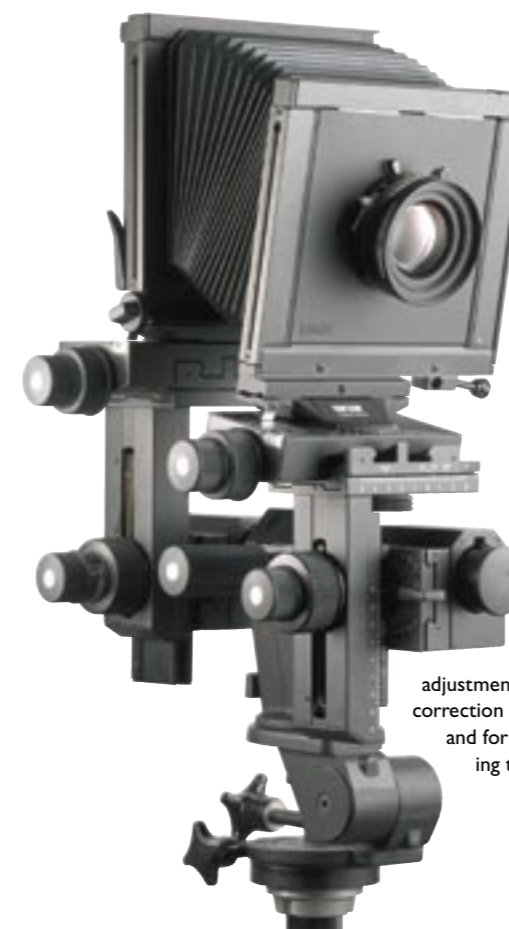
Even for the photographer on the move, there are ideal baseboard cameras which are light and compact, and which can be folded into a small space



The large format is attractive because of its supreme detail

All adjustment capabilities of the camera are useless if the image circle of the lens is inadequate

The parameters of quality named above, which are all determined by the quality of the lens and are merely aided by the properties of the camera, e.g., by simple and logical manipulation, mechanical precision and stability, are not everything. Even in the reproduction of perspective, there are high requirements. Converging vertical lines must be rectified, unless they are by exception part of the artistic concept. Whether complete rectification or partial rectification with residual perspective, lenses of a widely overdimensional image circle are essential for the necessary camera adjustments, because the optical axis is sometimes very far from the center of the image, and hence the entire image can be greatly displaced.



Monorail cameras make large adjustments possible for correction of perspective and for tilting according to the Scheimpflug principle

IMAGE CIRCLE QUALITY

Parallel displacement and Scheimpflug-tilting require latitude for an eccentric film position

In the image quality required, lenses of fixed cameras may cover only an image circle, which barely extends beyond the film edges. Adjustable cameras, on the other hand, require lenses with much larger image circles as an "adjustment reserve."



Panoramic cameras of the roll-film formats 6x12 cm and 6x17 cm also require lenses with an extremely large image circle

tion, etc., increase with the angle of view, in part largely progressively, large-format lenses are among those optical systems which are most difficult to calculate. For that reason, it is not surprising that there are only very few manufacturers world-wide who have mastered this challenge.

With know-how from decades of experience and the most modern technology to the highest optical achievement

Over many decades since the beginning of photography, SCHNEIDER-KREUZNACH has gathered experience in the design of adjustable large-format cameras, and with the no less difficult task of constructing high-performance lenses with large image circles, and in so doing, has set standards which are valid even today. The most modern methods of calculation used on powerful main-frame computers, computer-aided design procedures in the design of optical systems and their mechanical mounts, laser- and computer-assisted methods of measurement and testing integrated into all stages of the manufacturing process, and rigorous 100% final inspections – all these guarantee that Schneider lenses, at the current level of technology, will provide the highest possible imaging power.



The range of professional lenses offered by Schneider extends from the extreme wide-angle lens to the 120° large angle of view for large adjustment reserves to standard and macro-lenses of Apo-quality to Apo-Tele designs with short back focal distances for very long focal lengths which are usable with the customary extensions



Modern camera designs of the highest precision and stability can display their qualities only with adequate lenses

The larger the angle of view, the harder it is to keep all imaging errors too small to be noticed

The image circle is not sharply delimited, but is characterized by a light loss which, with the diaphragm open, begins slowly from the center; with a stopped-down lens, it begins later, but then increases rapidly toward the edge. The useful image-circle diameter, as indicated in the tables on page 25 for all Schneider lenses, refers not to the extreme edge of the image circle, at which the brightness declines to zero (this circle was formerly referred to as the "light circle"), but at the circular limit, where the picture quality falls below the limit defined by the manufacturer. The threshold values prescribed for large-format lenses by SCHNEIDER-KREUZNACH are set so high that no decline in performance is perceptible. Because the various imaging errors, such as spherical aberration, astigmatism, coma, curvature of field, distort-

CONTENTS

LARGE FORMAT LENSES

SUPER-ANGULON
5.6/38 XL, 5.6/47 XL, 5.6/58 XL, 5.6/72 XL,
5.6/90 XL, 6.8/90 8

SUPER-SYMMAR XL ASPHERIC
4.5/80 XL, 5.6/110 XL, 5.6/150 XL, 5.6/210 XL 10

APO-SYMMAR L
5.6/120 L, 5.6/150 L, 5.6/180 L, 5.6/210 L,
5.6/300 L, 8.4/480 L 12

MAKRO-SYMMAR HM
5.6/80 HM, 5.6/120 HM, 5.6/180 HM 14

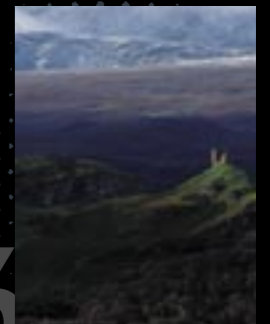
APO-TELE-XENAR
5.6/250, 5.6/400, 9/600, 12/800 16

List of products 18

Accessories / Specifications / Tables 20



8



16



12



10



14



SUPER-ANGULON

5.6/38 XL, 5.6/47 XL, 5.6/58 XL, 5.6/72 XL, 5.6/90 XL, 6.8/90



When the picture has to contain more than the eye sees, and razor sharp



Only the enormous angle of view makes this camera position possible – very close, with a dramatic vanishing-point perspective – without cutting off the top of the tower



The Super-Angulon on a baseboard camera is a perfect tool for the landscape and architecture photographer

The extremely large angle of view of the Super-Angulon, with a working aperture of up to 120°, offers, on the one hand, a comprehensive overview, e.g., for landscape panoramas, in which the eye of the viewer can literally walk around – thanks, too, to the outstanding sharpness of detail. On the other hand, it makes possible complete views, even under tight conditions of space (narrow streets with tall buildings, interior views) without the barrel-shaped distortion of fisheye lenses (the hotel tower of Dubai in the picture at the left actually has this curved form; it is not the result of distortion!). In addition, there are large adjustment reserves for the correction of converging parallel lines. All these properties, in connection with high resolution and brilliant contrast, make the Super-Angulon especially suited for landscape and architectural photography. The bright focusing image, because of the light loss resulting from the field of view with the diaphragm open, is advantageous for pictorial composition, and for achieving sharp focus outside of the center of the image. When stopping down, there is no resulting axial shift of focus.

To compensate for the light loss, centerfilters are necessary (see pages 20 and 23). The Super-Angulons are also available with a helical mount.



5.6/38 XL + Copal 0



5.6/47 XL + Copal 0



5.6/58 XL + Copal 0



5.6/72 XL + Copal 0



5.6/90 XL + Copal 0



6.8/90 + Copal 0



Large angle of view, large lenses!

So that the incident marginal rays entering at an angle of 60° from the optical axis with diaphragm open may produce a bright ground-glass image and at working aperture are not vignetted, the front and rear lenses of the Super-Angulon have to have a very large diameter. On the Super-Angulon 5.6/90 XL, the protecting ring can be unscrewed (picture at right, 78 mm diameter without ring), so that this extreme wide-angle lens is usable on cameras with a small lens board, e.g., on baseboard and compact outdoor cameras, which are favored in landscape, architectural, and industrial photography. Without the lens protection ring, the lens must be used with great care, and should not be removed with the rear component pointed downward, because the rear lens would then project beyond the edge of the rear mount.



SUPER-ANGULON



Hans-Georg Esch (Germany):
“The large image circle of the XL lenses makes perspectives for my architectural subjects possible which otherwise could not be achieved”



SUPER-SYMMAR XL ASPHERIC

4.5/80 XL, 5.6/110 XL, 5.6/150 XL, 5.6/210 XL



In nature photography, in which wide-angle lenses, primarily for reasons of composition, are indispensable for emphasizing the foreground and spatial effect, the usefulness of large adjustment reserves is often underestimated, because the sharp edges which can be spoiled by "converging vertical lines" almost never occur. But this photo shows how the huge massive stones recover their threatening dimensions only by rectification; otherwise, if looking upwards, their proportions would almost be trivialized because of the narrowing caused by perspective.

Super-compact despite great lens speed, thanks to modern aspheric technology

This series of lenses not only sets new technological standards, but it offers the photographer quite substantial practical advantages. An aspherical lens surface makes possible, at high maximum aperture, a compact structure, which is surprising given the large angle of view (at a working aperture of up to 105°) and very low weight. That is primarily an advantage for the photographer outside the studio, but it is also in many cases advantageous in connection with the longer wide-angle focal lengths necessary for large picture sizes. A further strength of this lens is the low dependence on scale. It is unusual for a wide-angle lens, that it can be used at a reproduction ratio of up to 1:3 without a loss of image quality. In the truest sense of the word, that opens new perspectives, e.g., for a "dynamic" still-life photography and for model (architectural) pictures which look realistic. Because of its use in architectural, industrial, and still-life photography, the distortion was corrected with special care.

Because of the "natural" light loss which as a matter of physics results from the Cos^4 -law, even at working apertures, a centerfilter must be used (see the table on page 23), just as with the Super-Angulon, when, with a large picture size and/or strong adjustment, not merely the central area of the giant image circle is used.



4.5/80 XL + Copal 0



5.6/110 XL + Copal 1



5.6/150 XL + Copal 1



5.6/210 XL + Copal 3



Performance requires effort

The well-known saying "from nothing comes nothing" purports to state: Whoever demands high performance should not stint on expense. For that reason, SCHNEIDER-KREUZNACH has employed aspheric technology, which, thanks to the most modern computerized numerically controlled machine tools and processing methods, has only recently been used at reasonable cost in mass production, together with refined methods of computerized calculation, so as to set a new standard for lenses with the Super-Symmar XL Aspheric.

So that its outstanding image quality achieved is not placed at risk, the photographer must observe the following rules:

1. The lens, which at great expense was adjusted at the factory during its installation in the shutter, should never be unscrewed and taken apart unnecessarily, in order not to change the very precise distance between the front and rear component which must be maintained, and in order to prevent its being screwed on crooked if both parts are not put back together properly.
2. If, for some reason, the shutter has to be replaced, this must be done only at the

factory, because the tolerances which the shutter has must be replaced by a new precise calibration. For just as a Formula-1 race car tuned for the highest performance responds more sensitively to "sand in the gears" than a tractor, so does the Super-Symmar XL Aspheric react more sensitively to deficient adjustment in connection with installation in the shutter than a more simply constructed lens.

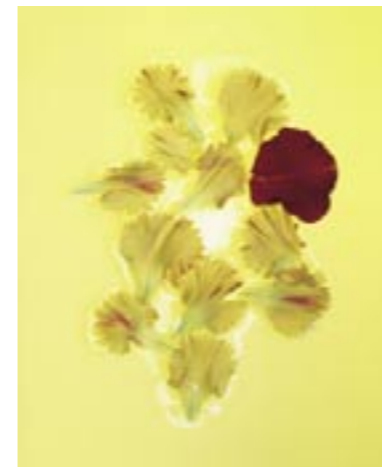


Jack Dykinga (USA): "Schneider lenses, with their unbelievable sharpness and subtle color reproduction, convey the soul of the landscape"



APO-SYMMAR L

5.6/120 L, 5.6/150 L, 5.6/180 L, 5.6/210 L, 5.6/300 L, 8.4/480 L



When the most delicate structures blend tone into tone, the modular transfer function of the lens is put to a hard test. Only the best lenses can separate such delicate structures clearly and distinctly. In this case, the Apo-Symmar L was subjected to even a double test, because the close-up photograph required a scale of reproduction which bordered on the macro area. Here the advantage of the high tolerance of scale of the Apo-Symmar L can be seen, which is evident up to the border of the macro area because of its exemplary sharpness.

If you could take only one lens with you to a desert island ...

The lens that can do everything equally well (and better than all other lenses) does not and will never exist, because some parameters of quality can only be increased at the expense of others. Nevertheless, the Apo-Symmar L can claim to come very close to this unattainable ideal. For the Apo-Symmar L is a highly corrected top lens of such balanced character that it can be regarded as the all-round candidate among the SCHNEIDER lenses. It combines the greatest sharpness, contrast, large angle of view without a visible decline in performance at the edge, even image field illumination (no centerfilter required), a high freedom from distortion, and independence of scale. For that reason, it is regarded as "the" standard lens, and especially among studio photographers is often the only lens type, even though used in several different focal lengths.

With an angle of view of 75° (56° with the 8.4/480 L), as a standard lens it offers very large adjustment possibilities for corrections of perspective and lens tilts according to the Scheimpflug principle, but it can also handle wide-angle tasks if lesser adjustment possibilities suffice. Its first-class resolution capacity permits the use of "long focal length" for smaller picture sizes, even with the most stringent requirements, and the insensitivity to scale makes possible close-up pictures up to about 1:3.



5.6/120 L + Copal 0



5.6/150 L + Copal 0



5.6/180 L + Copal 1



5.6/210 L + Copal 1



5.6/300 L + Copal 3



8.4/480 L + Copal 3

i

The correct use of filters

Filters not only enlarge the creative dimension through a large number of possibilities of manipulation (which should not be overdone, in order to sustain the effect), but are often necessary, e.g., for adaptation of the color temperature, for correction of color distortion, reduction of reflections, or for increasing the color saturation. Sometimes even several filters are necessary. Then the highest optical quality of the filters is especially important. For this reason, we recommend B+W filters, which are produced by SCHNEIDER-KREUZNACH with the same precision and care as our high-quality lenses. The Apo-Symmar L, like other Schneider lenses, has an additional filter thread on the mount of the rear lens (see the table on page 25). There a second filter can be attached – but never more than one! – for example, in order to avoid double images in pictures taken with very bright light sources as a result of reflections between the filters. In these cases, it is necessary to focus with the rear filter on.

APO-SYMMAR L



Hartmut Seehuber (Germany):
"High contrast, outstanding sharpness and freedom from scattered light are indispensable to me, and for that reason I have a high opinion of the Apo-Symmar L"



MAKRO-SYMMAR HM

5.6/80 HM, 5.6/120 HM, 5.6/180 HM



For every little thing that is supposed to look great, up to the tiniest detail



The range of interesting close-up subjects extends from nature to technology. An especially high degree of sharpness is always desirable in order to surprise the viewer with details in the printed picture or large-format exhibition photo which are often barely perceptible in the original. In the duplication of 35 mm slides and the reproduction of other flat copies, perfect flatness of image field and, especially in the technical area, freedom from distortion are required. All these properties can be found in the Makro-Symmar HM.

A lens can be optimized only for a certain reproduction ratio, and its quality diminishes, depending on its construction, more or less as those ratios change. Symmetrical or nearly symmetrical designs like the Apo-Symmar L are quite ratio-tolerant, i.e., from a distance to close-up approximately constantly satisfactory. But above about 1:3, even with this type of lens, a diminution of quality, at first minimal, and then increasing, can be noticed. For this reason, the Makro-Symmar was developed as an uncompromising special lens for ratios around 1:1, with a recommended working range of from 1:4 to 4:1. From 1:3, it even surpasses the excellent Apo-Symmar L, between approximately 1:2 and 2:1 it allows for reproductions and slide duplicates almost without loss, and only above 3:1 do the Apo-Componon lenses, optimized for very strong enlargement, begin to take the lead.

With high quality ULD (Ultra Low Dispersion) lenses, an apochromatic correction can be made, a feature which itself means freedom from color fringes, even with the most contrastive structures which run tangentially. The large image circle, which increases rapidly with the scale (see the table on page 25) admits of extreme camera adjustments. In order not to jeopardize the perfect sharpness by diffraction, the lens should never be stopped down more than necessary (see below).



5.6/80 HM + Copal 0



5.6/120 HM + Copal 0



5.6/180 HM + Copal 1



The stopping down for the depth of field of three-dimensional objects should remain small because of the danger of diffraction



Hans Strand (Sweden):
"Schneider lenses of all focal lengths stand out because of their extreme sharpness, high contrast, and color neutrality"



Diaphragm, exposure, diffraction

Even the most experienced photographers can get into difficulty if, in connection with close-up photographs, they have to offset the loss of light caused by inordinate extension of the bellows with an exposure correction. The cause of this confusion is the "effective aperture" when the focus is on infinity. The nominal f-stop number actually represents the proportion between focal length and diameter of the diaphragm aperture, which is assumed to be circular. On the other hand, the effective aperture which is definitive for the expo-

sure is the proportion of the image distance (not focal length!) to the diameter of the aperture. If M represents the magnification and f the focal length, the image distance is $d = (1+M) \cdot f$, and hence the relation of the nominal f-number k to the effective f-number $k_{eff} = (1+M) \cdot k$. Because the time required for correct exposure is proportional to the square of the f-stop number (example: an f-stop of 8 requires not double, but four times the exposure of f-stop 4), the multiplying factor $v = (1+M)^2$. However, so that you do not have to first calculate the scale of reproduction and from that the multiplying

factor, you will find on page 21 a small diagram which you can cut out or photocopy 1:1 and place on your template, in order to simply and quickly read off the scale and the multiplying factor directly on the focusing screen.

Furthermore, the effective aperture is the reason that in the macro area the diaphragm should not be stopped down too much. For at a scale of 1:1, the f-number of 22 results in an effective f-number of 45, and with a format of 4x5" and smaller, that, because of diffraction phenomena, can considerably reduce the great sharpness of your Makro-Symmar.



APO-TELE-XENAR

5.6/250, 5.6/400, 9/600, 12/800



Tom Wolf (Germany):
"The newly designed series Apo-Tele-Xenar
is impressive because of its compactness
and outstanding imaging power"



Since more than 30 years baseboard cameras have discarded as news cameras, and since for that reason no new large-format telephoto lenses were developed, really high-quality telephoto lenses have been lacking. The long-focal-length copying lenses adapted to the telephoto area require long bellows extensions corresponding to their focal length; these are only possible in connection with monorail cameras with especially made extra long monorails. But precisely because the baseboard camera and other camera types, trimmed down to the desired compactness and lightness for mobile use are preferred in landscape, industrial, and architectural photography, the new Apo-Tele-Xenars meet the long-felt wishes of many outdoor professionals.

For pictures with long focal lengths on cameras without a large bellows extension

While in studio photography, the most important domain of the large format, very long focal lengths are neither necessary nor useful, they are often used in landscape, nature, industrial, and architectural photography. Portrait photography, too, is an important area of application. The newly calculated, extremely compact, light Apo-Tele-Xenar lenses, optimized in performance with new types of glass and through elaborate computer programs, are bringing some fresh air, as well as a contemporary level of quality, into the area of large-format telephoto photography.

Apochromatic correction and high contrast make for brilliant long distance photographs without color fringes, which otherwise are especially clearly visible at long focal lengths, since the lateral chromatic aberration without apochromatic correction is approximately proportional to the focal length. The short flange focal distance (the distance from the lens board to the focusing screen) resulting from the telephoto (barlow) design of the lens makes possible a focal length which is 30% to 40% longer than the maximum camera extension normally allows. The fact that the angle of view had to be smaller than in other large-format lenses – as the price, so to speak, for the compactness achieved – is not a limitation, there are still reserves for movements.



The focal lengths of various formats compared

Anyone getting into large format photography for the first time often has problems in imagining the pictorial effect of the much longer focal lengths there. Particularly with telephoto lenses, there are often unrealistic ideas, because, e.g., a 300 mm focal length for a 35 mm camera is quite a "long tube", but for a format of 8x10" or 18x24 cm it is nothing more than the normal focal length. At the same time, the conversion is quite simple. Because of the different lengths of the sides, the relevant variable is always the diagonal of the image, e.g., 43 mm with a 35 mm film, and 154 mm with 4x5". The proportion of the format diagonals yields the conversion factor; in the example given, it is $154:43 \approx 3.6$. Hence, the normal focal length of a 35 mm film corresponds in format 4x5" to a focal length of $3.6 \cdot 50 \text{ mm} = 180 \text{ mm}$. Conversely, a focal length of 300 mm in format 4x5" corresponds in a 35 mm film to $300 \text{ mm}:3.6 \approx 85 \text{ mm}$. On page 21, there is a table which gives you all the conversion factors for all of the usual large formats.

APO-TELE-XENAR



5.6/250 + Copal 1

16
17



5.6/400 + Copal 3



9/600 + Copal 3



12/800 (rear component)

The Apo-Tele-Xenars 9/600 and 12/800 are modular, with an interchangeable rear component. They share the same front element, so that only the other rear component is required in addition to have both focal lengths available.

SUPER-ANGULON

5.6/38 XL, 5.6/47 XL, 5.6/58 XL,
5.6/72 XL, 5.6/90 XL, 6.8/90



5.6/38 XL + Copal 0



5.6/47 XL + Copal 0



5.6/58 XL + Copal 0



5.6/72 XL + Copal 0



5.6/90 XL + Copal 0



6.8/90 + Copal 0

SUPER-ANGULON

Landscape · Architecture ·
Industry



SUPER-SYMMAR XL ASPHERIC

4.5/80 XL, 5.6/110 XL,
5.6/150 XL, 5.6/210 XL



4.5/80 XL + Copal 0



5.6/110 XL + Copal 1



5.6/150 XL + Copal 1



5.6/210 XL + Copal 3

SUPER-SYMMAR XL ASPHERIC

Landscape · Architecture · Industry · Studio



18
—
19

APO-SYMMAR L

5.6/120 L, 5.6/150 L, 5.6/180 L,
5.6/210 L, 5.6/300 L, 8.4/480 L



5.6/120 L + Copal 0



5.6/150 L + Copal 0



5.6/180 L + Copal 1



5.6/210 L + Copal 1



5.6/300 L + Copal 3



8.4/480 L + Copal 3

APO-SYMMAR L

All-round use



MAKRO-SYMMAR HM

5.6/80 HM, 5.6/120 HM,
5.6/180 HM



5.6/80 HM + Copal 0



5.6/120 HM + Copal 0



5.6/180 HM + Copal 1

MAKRO-SYMMAR HM

Macro · Reproduction · Duplication



APO-TELE-XENAR

5.6/250, 5.6/400, 9/600,
12/800



5.6/250 + Copal 1



5.6/400 + Copal 3



9/600 + Copal 3



12/800 (rear component)

APO-TELE-XENAR

Landscape · Architecture · Industry · Portrait



Accessories

Shutters, helical mounts,
centerfilters



Copal 0



Copal 1



Copal 3



Copal Press



Rollei electronic shutter



Helical mount



Centerfilter

ACCESSORIES

TECHNICAL INFORMATION



Copal 0 Mechanical shutter with maximum iris opening of 24 mm. Shutter speeds T, B, and 1 s in whole steps up to 1/500 s. 5-blade iris shutter, equipped by SCHNEIDER-KREUZNACH with three click stops per aperture increment. Weight 115 g.



Copal 1 Mechanical shutter with maximum iris opening of 30 mm. Shutter speeds T, B, and 1 s in whole steps up to 1/400 s. 7-blade iris shutter, equipped by SCHNEIDER-KREUZNACH with three click stops per aperture increment. Weight 160 g.



Copal 3 Mechanical shutter with maximum iris opening of 45 mm. Shutter speeds T, B, and 1 s in whole steps up to 1/125 s. 7-blade iris shutter, equipped by SCHNEIDER-KREUZNACH with three click stops per aperture increment. Weight 340 g.



Copal Press 0 / 1 Self-cocking mechanical shutter with maximum iris opening of 24 mm or 30 mm (corresponding to size 0 or size 1). Shutter speeds B and 1 s in whole steps up to 1/125 s. 5- or 6-blade iris shutter, continuous setting. Weight 100 g or 115 g.

ACCESSORIES



Rollei electronic shutter 0 / 1 Shutter electronically remote-controllable with the control unit Rollei LensControl S, with maximum iris opening of 24 mm or 30 mm (corresponding to size 0 or 1). Shutter speeds B and 30 s to 1/500 s or 1/300 s respectively in three click-stops per aperture increment. 5-blade iris shutter adjustable in 1/10 steps. Weight 306 g.



Helical mount Focusing tube of variable length needed with cameras without intrinsic focusing mechanism (e.g., in panoramic cameras). Maximum extension 6.5 mm. Weight 78 g without adapter. Usable only in conjunction with shutters Copal 0 or Copal Press 0. Every helical mount has a distance scale individually calibrated to the focal length of the built-in lens.



Centerfilter A neutral gray, graduated-density filter with density diminishing from a maximum at the center to complete transparency at the edge to compensate to a great extent for the light loss caused by the laws of physics. Because of the individual correlation of the density gradient to the angle of view of the lens and the position of the filter in front of the lens (distance to the main plane on the object-side), only the centerfilter recommended for use specifically with lens in question should be used.

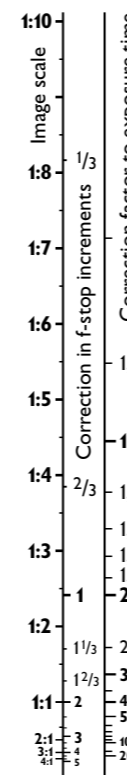
Choice of the optimally correlated centerfilter and combination with an additional filter

The centerfilter for the reduction of unavoidable natural light loss caused by physical laws and determined by the angle of view must be exactly correlated in its effective diameter and in the density gradient with the wide-angle lens. Not only the angle of view is decisive, which for several Super-Angulons or various Super-Symmars can be the same, but also the position of the filter relative to the nodal point of the object-side which is determined by the barrel of the lens. For optimum effect, it is therefore not sufficient simply to use a centerfilter of the proper thread diameter. For this reason, you can find a table on page 23 which indicates the optimal centerfilter for each case (even for older, no longer produced Super-Angulons), including its order number. If, in addition to a centerfilter, a further filter is necessary, e.g., to adjust the color temperature, this filter must be placed in front of the centerfilter (not between the centerfilter and the lens).

Conversion factors for comparison of focal lengths at various film formats

The portion of the subject filling the picture captured from a camera position depends both on the focal length and the film format. In order to capture the same image content in a larger picture size, the focal length chosen has to be increased by the corresponding format factor. Conversely, beginning with the larger film size, the focal length has to be divided by the format factor in order to get the focal length, which will include the image content in the smaller film format.

	The format factor as basis for calculation		
	24x36 mm	4,5x6 cm	6x7 cm
amounts for			
6x7 cm	2.0	1.3	1.0
6x9 cm	2.3	1.4	1.1
9x12 cm	3.3	2.0	1.6
4x5"	3.6	2.2	1.7
5x7"	4.8	3.0	2.3
8x10"	7.2	4.4	3.5



Simple determination of the scale and multiplying factor in the macro area

The formula often given in photography books and periodicals, $v = (1+M)^2$, to compensate for the light loss caused by the bellows extension in close-up photographs requires knowledge of the precise reproduction ratio M and some calculation. The diagram at the left does it for you. Place the diagram or a photocopy of the original size on your template so that the basic line on the image on the focusing screen is parallel to the grid lines of the focusing screen, and the zero line falls on a perpendicular grid line. Then, at a distance of 1 cm on the focusing screen, read on the next grid line the scale of reproduction, the multiplying factor, as well as the correction factor corresponding to it in aperture increments. Either the time or the aperture is to be corrected, but not both, because that would constitute a double correction, which would then turn an underexposure without correction into just as large an overexposure.

i

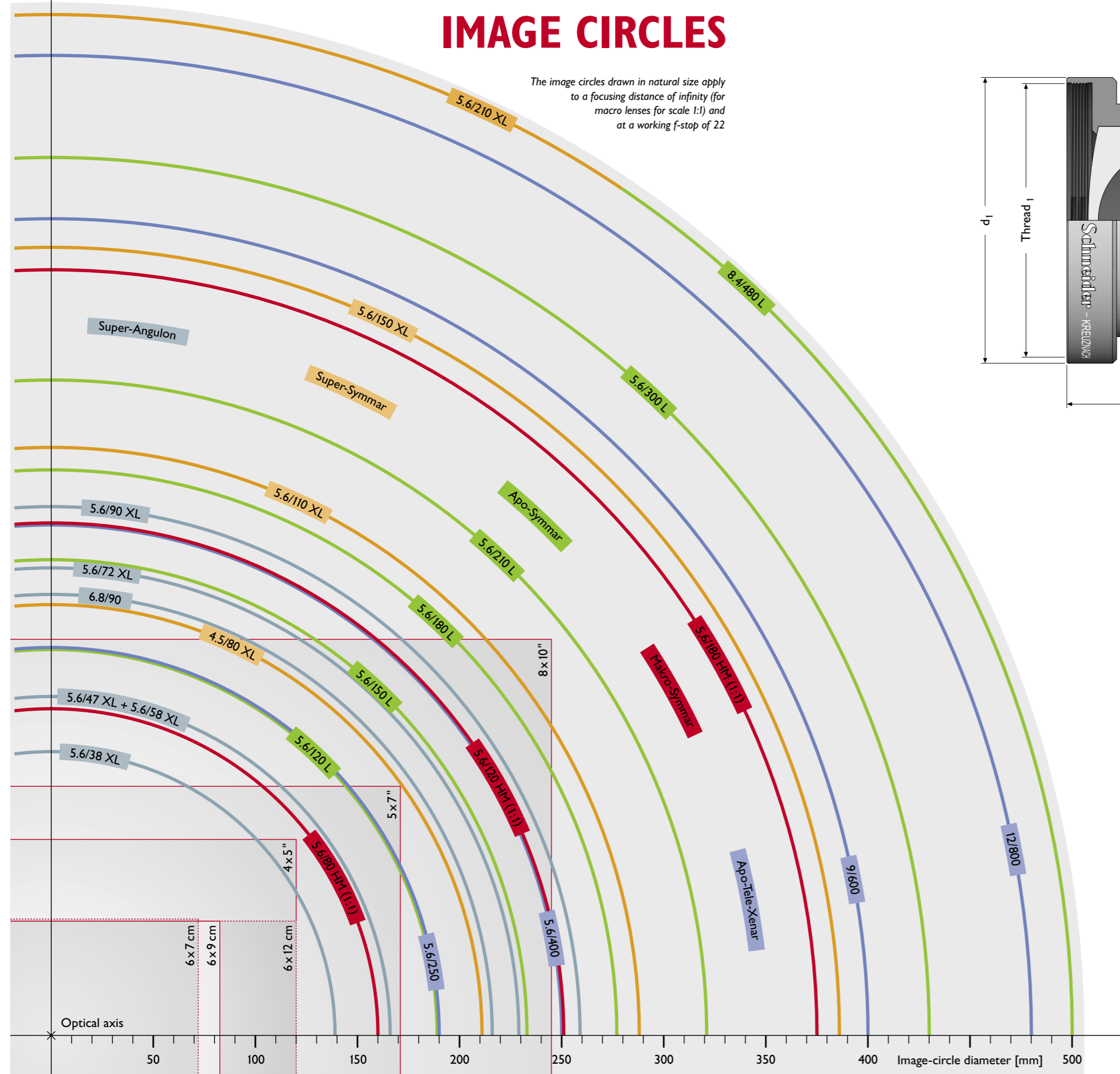
Confidence is good, inspection is better

Although you can have confidence in the first-class quality of your Schneider lenses, you cannot avoid critically examining the slides and negatives that you have made from them, because other mistakes are possible which can cause incorrect focus, movement, or improper film position, as well as other non-technical flaws, such as the persons being photographed having their eyes closed. The high quality magnifiers from SCHNEIDER-KREUZNACH, which are available with 3x, 4x, and 10x enlargement (the 10x lens also available with built-in LED illumination), help you in this task with outstanding sharpness, freedom from distortion, and with the best viewing posture for relaxed observation.

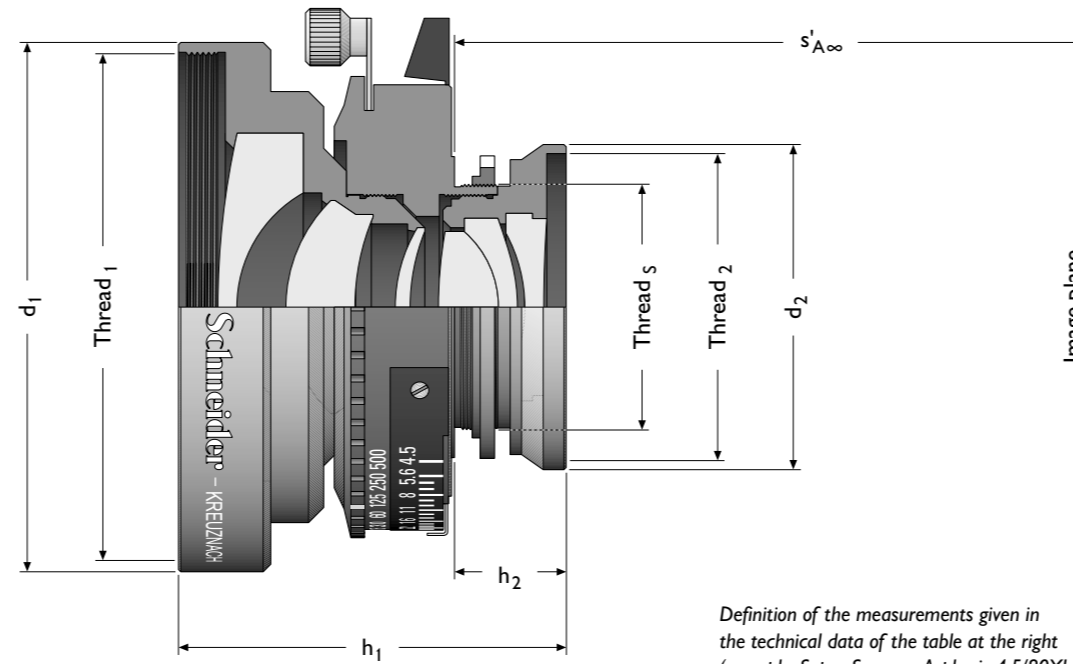


IMAGE CIRCLES

The image circles drawn in natural size apply to a focusing distance of infinity (for macro lenses for scale 1:1) and at a working f-stop of 22



SPECIFICATIONS



Definition of the measurements given in the technical data of the table at the right (example: Super-Symmar Aspheric 4.5/80XL in the shutter Copal 0)

Available centerfilters (even for older lenses)	Centerfilter identification	Exposure correction as a filter factor	Exposure correction in apertures	Centerfilter front screw-in thread (for attachment to the lens)	Front-side screw-in thread (for an additional filter)	Order number of the centerfilter	
Super-Angulon	5.6/38 XL	IIa	4x	2	M 72 x 0.75	M 82 x 0.75	45385
	5.6/47 XL	IIIc	4x	2	M 67 x 0.75	M 86 x 1	25637
optional with less correction		IIIb	3x	1.5	M 67 x 0.75	M 86 x 1	10590
	5.6/58 XL	IIIb	3x	1.5	M 67 x 0.75	M 86 x 1	10590
	5.6/72 XL	IVb	4x	2	M 95 x 1	M 112 x 1.5	25638
optional with less correction		IVa	3x	1.5	M 95 x 1	M 112 x 1.5	10591
	5.6/90 XL	IVa	3x	1.5	M 95 x 1	M 112 x 1.5	10591
	6.8/90	IIIb	3x	1.5	M 82 x 0.75	M 105 x 1	28300
Super-Angulon (old)	5.6/47 *	II	3x	1.5	M 49 x 0.75	M 67 x 0.75	39286
	5.6/47 *	II	3x	1.5	M 52 x 0.75	M 67 x 0.75	16190
	5.6/65	III	3x	1.5	M 67 x 0.75	M 86 x 1	10598
	5.6/75	III	3x	1.5	M 67 x 0.75	M 86 x 1	10598
	5.6/90	IV	3x	1.5	M 82 x 0.75	M 105 x 1	10599
	8/90	IIIb	3x	1.5	M 67 x 0.75	M 86 x 1	10590
	8/120	IV	3x	1.5	M 82 x 0.75	M 105 x 1	10599
	8/165	V	3x	1.5	M 110 x 1	M 125 x 1	10592
	8/210	VI	3x	1.5	M 135 x 1	M 152 x 1	10593
Super-Symmar Aspheric	4.5/80 XL	IIIb	3x	1.5	M 67 x 0.75	M 86 x 1	10590
	5.6/110 XL	IIIb	3x	1.5	M 67 x 0.75	M 86 x 1	10590
	5.6/150 XL	IVa	3x	1.5	M 95 x 1	M 112 x 1.5	10591
	5.6/210 XL	VI	3x	1.5	M 135 x 1	M 152 x 1	10593

* Caution: note the thread size (the older model has M 49 x 0.75, the newer model has M 52 x 0.75)

Optical and mechanical dimensions	Rel. aperture / focal length [mm]	Optical design (element groups)	Effective focal length ± 1% [mm]	Front-side screw-in thread for filters and other accessories	Max. diameter of the front mount [mm]	Max. diameter of the rear mount [mm]	Rear screw-in thread for a further filter	Total overall height [mm]	Flange surface to rear edge of mount [mm]	Mounting thread of the shutter to the lens board attachment	Flange focal distance [mm]	Smallest diaphragm aperture	Shutter type and shutter size	Weight with shutter indicated [grams]	Order number of the lens including shutter
STANDARD LENSES															
Super-Angulon	5.6/38 XL	8/4	39.4	M 72 x 0.75	75.0	60.0	-	59.5	30.4	M 32.5 x 0.5	52.1	22	Copal 0	274	43260
	5.6/47 XL	8/4	48.0	M 67 x 0.75	70.0	63.5	-	60.8	30.1	M 32.5 x 0.5	59.1	32	Copal 0	310	25044
	5.6/58 XL	8/4	58.2	M 67 x 0.75	70.0	60.0	-	65.5	31.0	M 32.5 x 0.5	70.0	32	Copal 0	330	16819
	5.6/72 XL	8/4	72.0	M 95 x 1	100.0	75.0	-	81.5	35.6	M 32.5 x 0.5	82.2	45	Copal 0	520	25587
	5.6/90 XL	8/4	90.7	M 95 x 1	100.0	86.0*	-	95.9	43.6	M 32.5 x 0.5	103.5	45	Copal 0	665	16823
	6.8/90	8/4	90.6	M 82 x 0.75	90.0	80.0	-	97.7	45.4	M 32.5 x 0.5	103.4	64	Copal 0	655	28185
Super-Symmar Aspheric	4.5/80 XL	6/4	81.0	M 67 x 0.75	70.0	43.0	-	51.3	14.8	M 32.5 x 0.5	84.7	45	Copal 0	274	35535
	5.6/110 XL	6/4	109.9	M 67 x 0.75	70.0	54.0	M 52 x 0.75	60.0	18.9	M 39 x 0.75	117.2	45	Copal 1	425	12466
	5.6/150 XL	6/4	147.7	M 95 x 1	100.0	65.0	M 62 x 0.75	80.0	24.2	M 39 x 0.75	157.9	64	Copal 1	740	12462
	5.6/210 XL	6/4	209.2	M 135 x 1	140.0	75.0	M 72 x 0.75	120.0	35.6	M 62 x 0.75	216.3	64	Copal 3	2010	25213
Apo-Symmar	5.6/120 L	6/4	123.2	M 52 x 0.75	54.0	54.0	M 52 x 0.75	42.4	16.5	M 32.5 x 0.5	116.3	64	Copal 0	210	29328
	5.6/150 L	6/4	151.5	M 58 x 0.75	60.0	60.0	M 58 x 0.75	53.1	21.1	M 32.5 x 0.5	142.2	64	Copal 0	267	29416
	5.6/180 L	6/4	180.4	M 72 x 0.75	75.0	75.0	M 72 x 0.75	62.8	28.1	M 39 x 0.75	177.7	64	Copal 1	435	29420
	5.6/210 L	6/4	209.0	M 77 x 0.75	80.0	80.0	M 77 x 0.75	73.5	35.8	M 39 x 0.75	208.1	64	Copal 1	546	29423
	5.6/300 L	6/4	296.3	M 105 x 1	110.0	80.0	M 77 x 0.75	96.1	35.3	M 62 x 0.75	283.1	64	Copal 3	1150	29426
	8.4/480 L	6/4	469.4	M 105 x 1	110.0	110.0	M 105 x 1	129.4	55.7	M 62 x 0.75	454.0	64	Copal 3	1850	29428
Apo-Tele-Xenar	5.6/250	5/5	250.3	M 82 x 0.75	86.0	58.0	-	105.0	36.6	M 39 x 0.75	195.1	64	Copal 1	692	11383
	5.6/400	5/4	387.4	M 82 x 0.75	85.0	60.0	M 58 x 0.75	107.0	28.3	M 62 x 0.75	285.1	64	Copal 3	916	32676
	9/600	5/5	598.5	M 105 x 1	112.0	90.0	M 86 x 0.75	168.5	65.9	M 62 x 0.75	461.3	64	Copal 3	1940	28171
	12/800	6/5	796.6	M 105 x 1	112.0	90.0	M 86 x 0.75	169.9	67.3	M 62 x 0.75	628.2	64	Copal 3	2132	28173
MACRO LENSES															
Makro-Symmar	5.6/80 HM	8/4	81.5	M 40.5 x 0.5	42.0	31.5	-	47.9	19.6	M 32.5 x 0.5	159.4	32	Copal 0	200	25592
	5.6/120 HM	8/4	119.9	M 40.5 x 0.5	42.0	37.5	-	55.1	23.2	M 32.5 x 0.5	235.0	45	Copal 0	230	39900
	5.6/180 HM	8/4	179.9	M 58 x 0.75	60.0	57.0	-	80.4	35.7	M 39 x 0.75	354.3	64	Copal 1	500	39905

* Diameter of the rear mount with unscrewed lens protection ring only 78 mm (important for cameras with small lens boards, e.g., for some baseboard cameras)

For the meaning of the abbreviations in the heading of the standard and macro-lenses, see the drawing at left
The flange focal distance s'_A applies, in connection with macro lenses, not to the usual setting on infinity customary for other lenses, but rather to the image scale of 1:1

For a diagrammatic representation of the image circles at a setting of infinity (macro lenses at a scale of 1:1) see the left page 22
For exact numerical values for angle of view, image-circle diameter, and adjustment possibilities with different roll-film and sheet-film sizes, see the table on the following page

Angle of view, image circles, and range of lens displacements							Max. lens displacement at f-stop 22 and landscape format (for portrait format the values are to be reversed) in focus on infinity (standard lenses) or for scale 1:1 (macro lenses)											
Lens name	Rel. aperture / focal length [mm]	Recommended centerfilter type	Angle of view at full aperture [degree]	Image-circle diameter at full aperture [mm]	Angle of view at f-stop 22 [degree]	Image-circle diameter at f-stop 22 [mm]	6 x 7 cm		6 x 9 cm		6 x 12 cm		4 x 5"		5 x 7"		8 x 10"	
							vertical [mm]	horizontal [mm]	vertical [mm]	horizontal [mm]	vertical [mm]	horizontal [mm]	vertical [mm]	horizontal [mm]	vertical [mm]	horizontal [mm]	vertical [mm]	horizontal [mm]
STANDARD LENSES (set on infinity)							6 x 7 cm		6 x 9 cm		6 x 12 cm		4 x 5"		5 x 7"		8 x 10"	
Super-Angulon	5.6/38 XL	IIa	101°	96	120°	139	↑ 31 → 28	↑ 28 → 22	↑ 7 → 4									
	5.6/47 XL	IIIc	98°	110	120°	166	↑ 47 → 42	↑ 44 → 37	↑ 29 → 18	↑ 9 → 8								
	5.6/58 XL	IIIb	96°	129	110°	166	↑ 47 → 42	↑ 44 → 37	↑ 29 → 18	↑ 9 → 8								
	5.6/72 XL	IVb	98°	166	115°	229	↑ 81 → 75	↑ 79 → 70	↑ 70 → 51	↑ 50 → 44	↑ 16 → 12							
	5.6/90 XL	IVa	96°	201	110°	259	↑ 96 → 90	↑ 95 → 85	↑ 87 → 66	↑ 67 → 60	↑ 37 → 30							
	6.8/90	IIIb	92°	188	100°	216	↑ 74 → 68	↑ 72 → 63	↑ 62 → 44	↑ 42 → 37	↑ 6 → 4							
Super-Symmar Aspheric	4.5/80 XL	IIIb	86°	150	105°	211	↑ 71 → 66	↑ 69 → 60	↑ 59 → 42	↑ 39 → 34	↑ 2 → 1							
	5.6/110 XL	IIIb	80°	186	105°	288	↑ 111 → 105	↑ 110 → 100	↑ 103 → 81	↑ 83 → 76	↑ 56 → 46							
	5.6/150 XL	IVa	80°	248	105°	386	↑ 162 → 155	↑ 161 → 150	↑ 155 → 131	↑ 135 → 127	↑ 113 → 98	↑ 52 → 44						
	5.6/210 XL	VI	81°	357	100°	500	↑ 219 → 212	↑ 219 → 207	↑ 215 → 188	↑ 195 → 185	↑ 175 → 158	↑ 121 → 108						
Apo-Symmar	5.6/120 L		62°	148	75°	189	↑ 59 → 54	↑ 57 → 49	↑ 45 → 30	↑ 25 → 21								
	5.6/150 L		62°	182	75°	233	↑ 83 → 77	↑ 81 → 72	↑ 72 → 53	↑ 52 → 46	↑ 19 → 15							
	5.6/180 L		62°	217	75°	277	↑ 106 → 100	↑ 104 → 94	↑ 97 → 76	↑ 77 → 70	↑ 48 → 40							
	5.6/210 L		62°	251	75°	321	↑ 128 → 122	↑ 127 → 117	↑ 121 → 98	↑ 101 → 93	↑ 76 → 64	↑ 7 → 5						
	5.6/300 L		62°	356	72°	430	↑ 184 → 177	↑ 183 → 172	↑ 178 → 153	↑ 158 → 150	↑ 137 → 121	↑ 80 → 69						
	8.4/480 L		44°	384	56°	500	↑ 219 → 212	↑ 219 → 207	↑ 215 → 188	↑ 195 → 185	↑ 175 → 158	↑ 121 → 108						
Apo-Tele-Xenar	5.6/250		38°	171	42°	190	↑ 60 → 55	↑ 58 → 49	↑ 46 → 31	↑ 26 → 22								
	5.6/400		36°	250	36°	250	↑ 92 → 86	↑ 90 → 81	↑ 82 → 62	↑ 62 → 55	↑ 31 → 24							
	9/600		29°	312	37°	400	↑ 169 → 162	↑ 168 → 157	↑ 163 → 138	↑ 143 → 134	↑ 121 → 106	↑ 61 → 52						
	12/800		28°	400	34°	480	↑ 209 → 202	↑ 208 → 197	↑ 204 → 178	↑ 184 → 175	↑ 164 → 147	↑ 109 → 97						
MACRO LENSES (set for scale M)							6 x 7 cm		6 x 9 cm		6 x 12 cm		4 x 5"		5 x 7"		8 x 10"	
Makro-Symmar	5.6/80 HM	1:2	47°	106	52°	120	↑ 20 → 17	↑ 15 → 12										
		1:1	47°	141	52°	160	↑ 43 → 39	↑ 40 → 34	↑ 25 → 15	↑ 4 → 4								
		2:1	47°	212	52°	239	↑ 85 → 80	↑ 83 → 75	↑ 75 → 56	↑ 55 → 49	↑ 23 → 18							
5.6/120 HM	1:2	47°	157	55°	188	↑ 58 → 54	↑ 56 → 48	↑ 44 → 30	↑ 23 → 20									
	1:1	47°	210	55°	251	↑ 92 → 86	↑ 91 → 81	↑ 82 → 62	↑ 61 → 55	↑ 30 → 24								
	2:1	47°	313	55°	375	↑ 156 → 149	↑ 155 → 144	↑ 150 → 125	↑ 129 → 121	↑ 106 → 92	↑ 44 → 37							
5.6/180 HM	1:2	47°	234	55°	281	↑ 107 → 102	↑ 106 → 96	↑ 99 → 78	↑ 79 → 72	↑ 51 → 41								
	1:1	47°	313	55°	375	↑ 156 → 149	↑ 155 → 144	↑ 150 → 125	↑ 129 → 121	↑ 106 → 92	↑ 44 → 37							
	2:1	47°	468	55°	562	↑ 250 → 244	↑ 250 → 238	↑ 247 → 220	↑ 226 → 216	↑ 207 → 189	↑ 155 → 141							



Jos. Schneider Optische Werke GmbH
Business area: Photo Optics
Ringstr. 132 · D-55543 Bad Kreuznach
Phone: +49-(0)671-60 12 82
Fax: +49-(0)671-60 11 08
foto@schneiderkreuznach.com
www.schneiderkreuznach.com